

# VARIO30

## SURFACE PROFILES

### PROFILE NAWIERZCHNIOWE



scissors  
nożyczki



hacksaw  
piłka



glue  
klej



drill  
wiertarka











screwdriver  
wkrętek



metal shears  
nożyce do metalu



cotton gloves  
rękawiczki

profiles profile	endings zaślepki	assistant profiles profil pomocnicze	mountings mocowania
 <b>08 power supply cover VARIO30-08</b> osłona zasilacza VARIO30-08	<b>08A, 08B</b> <b>08C, 08D</b>	 <b>09 profile VARIO30-09</b> profil VARIO30-09	 <b>Y<sup>1</sup></b> <b>Y flexible mounting plate</b> uchwyt Y sprężysty   <b>Y<sup>2</sup></b> <b>cone Y flexible mounting plate</b> uchwyt Y sprężysty cone   <b>T</b> <b>T mounting plate</b> uchwyt T
 <b>01 LED profile VARIO30-01</b> profil LED VARIO30-01	<b>01</b>	 <b>10 profile VARIO30-10</b> profil VARIO30-10  <b>FIX16</b>	
 <b>02 LED profile VARIO30-02</b> profil LED VARIO30-02	<b>02</b>		
 <b>03 LED profile VARIO30-03</b> profil LED VARIO30-03	<b>03</b>		

## PENDANT VARIANTS

### WARIANTY WISZĄCE

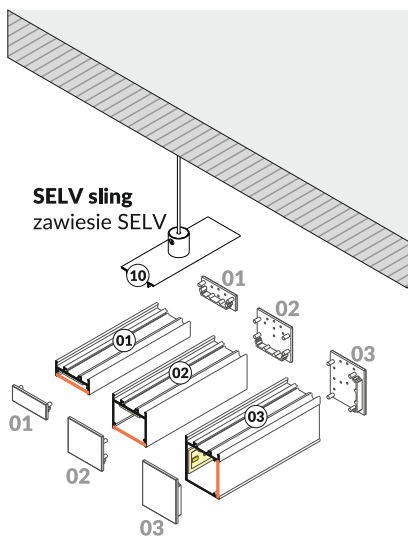

## SURFACE VARIANTS

### WARIANTY NAWIERZCHNIOWE

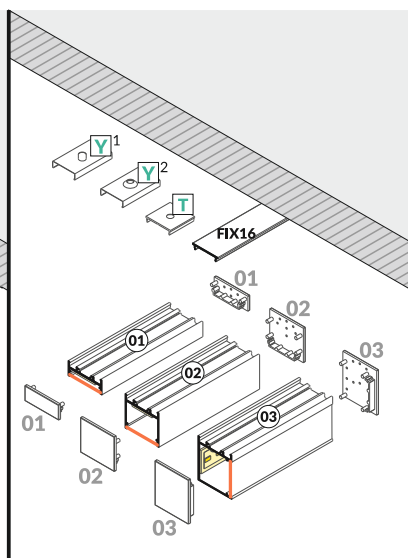

## VARIANTS WITH POWER SUPPLY COVER

### WARIANTY Z OSŁONĄ ZASILACZA

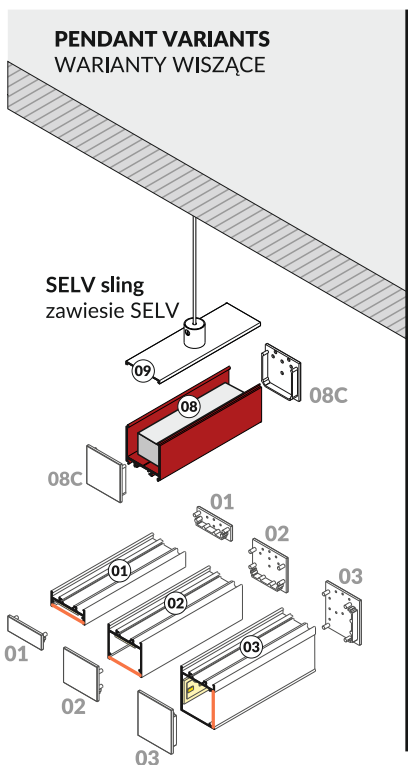

## SURFACE VARIANTS

### WARIANTY NAWIERZCHNIOWE

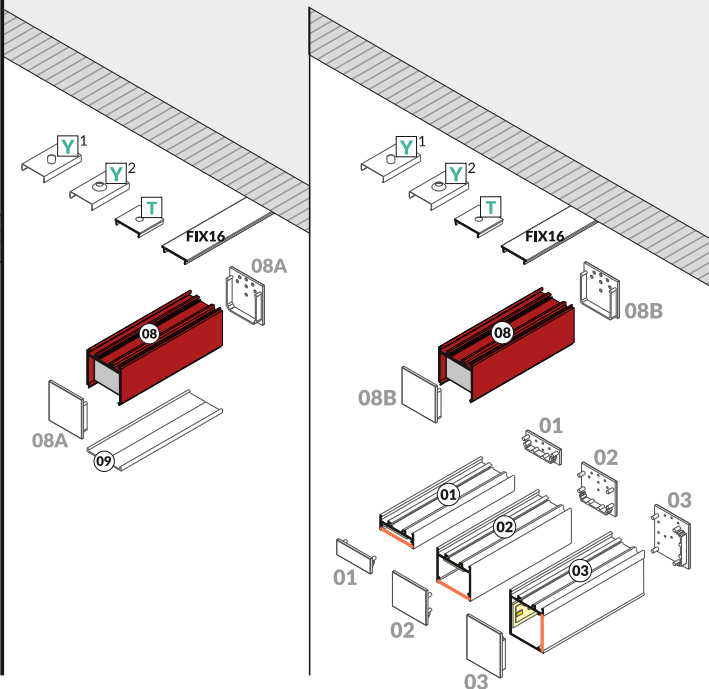

## TWO SIDES VARIANTS

### WARIANTY DWUSTRONNE

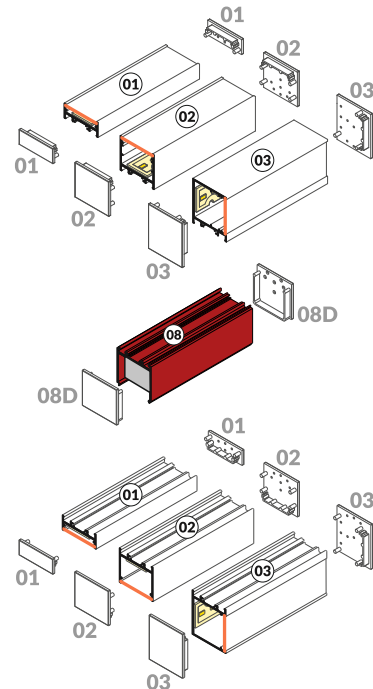

I

**VARIO30-01**  
**VARIO30-02**  
**VARIO30-03**  
 diffuser / klosz  
**A9, C9, D9, E9**

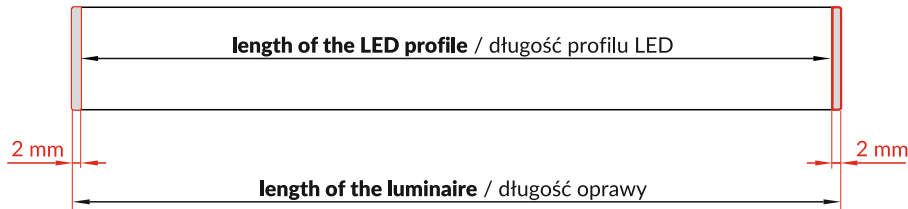

II

**VARIO30-01**  
**VARIO30-02**  
**VARIO30-03**  
 diffuser / klosz  
**A9, C9, D9, E9**

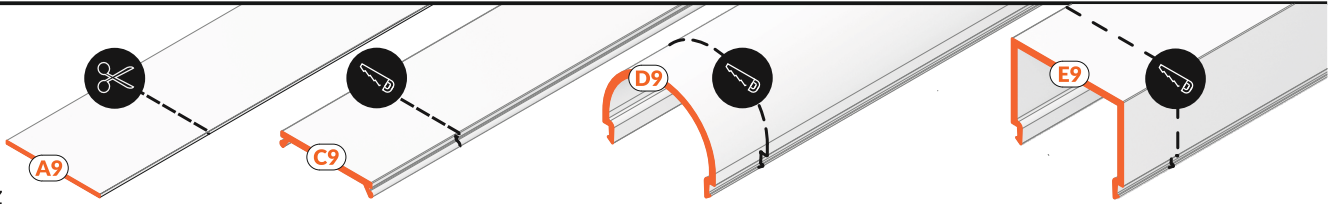

**Note!** The length of the cover is equal to the length of the profile.  
**Uwaga!** Długość klosza równa jest długości profilu.

III

**VARIO30-01**  
 diffuser / klosz  
**A9, C9**

**RECOMMENDED LED STRIP**  
 REKOMENDOWANA TAŚMA LED

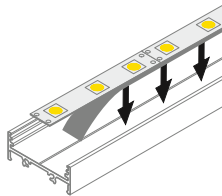
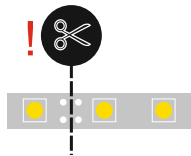

**VARIO30-01**  
 diffuser / klosz  
**D9, E9**

**RECOMMENDED LED MODULE:**  
 REKOMENDOWANY MODUŁ LED:  
**PHILIPS Fortimo LED strip LV**

**Note!** Possible to use LED strip  
 max 30 mm width  
**Uwaga!** Możliwe użycie taśmy LED  
 o maksymalnej szerokości 30 mm

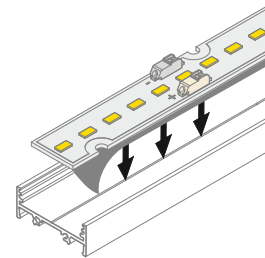

**double-sided adhesive thermally  
 conductive tape 15 mm x 50 mm**  
 taśma termoprzewodząca dwustronna  
 15 mm x 50 mm

**VARIO30-02**  
**VARIO30-03**  
 diffuser / klosz  
**A9, C9, D9, E9**

**RECOMMENDED LED MODULE:**  
 REKOMENDOWANY MODUŁ LED:  
**PHILIPS Fortimo LED strip LV**

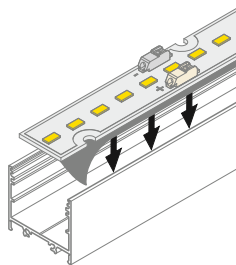

**Note!** Possible to use LED strip  
 max 30 mm width  
**Uwaga!** Możliwe użycie taśmy LED  
 o maksymalnej szerokości 30 mm

**double-sided adhesive thermally  
 conductive tape 15 mm x 50 mm**  
 taśma termoprzewodząca dwustronna  
 15 mm x 50 mm

## IV ACCESSORIES / AKCESORIA

**VARIO30 LED clamp**  
 docisk LED VARIO30

**VARIO30-02**  
 diffuser / klosz  
**A9, C9, D9, E9**

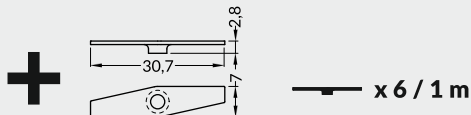

A9 C9 D9 E9

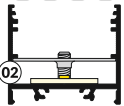

**VARIO30-02**

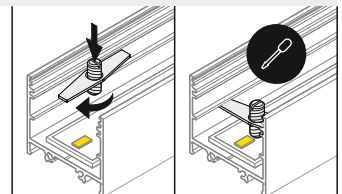

**VARIO30 LED 1 clamp**  
docisk LED VARIO30 1

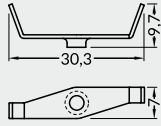

x 6 / 1 m

**VARIO30-03**  
diffuser / klosz  
A9, C9, D9, E9



A9 C9 D9 E9

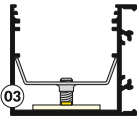

VARIO30-03

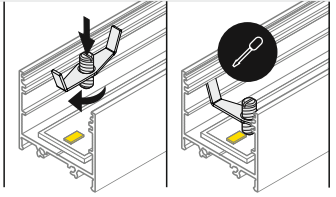

**VARIO30 LED mounting**  
mocowanie LED VARIO30

**VARIO30-02**  
**VARIO30-03**  
diffuser / klosz  
A9, C9, D9, E9

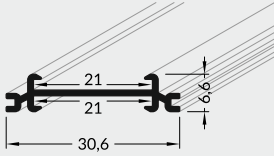

A9 C9 D9 E9

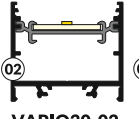

VARIO30-02

D9 E9

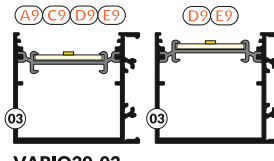

VARIO30-03

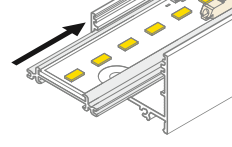
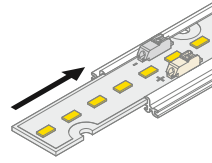
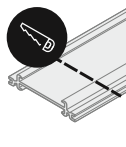

**VARIO30 LED mounting**  
mocowanie LED VARIO30

**VARIO30-02**  
**VARIO30-03**  
diffuser / klosz  
A9, C9, D9, E9

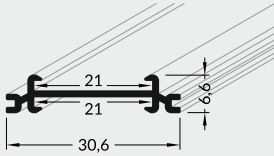

**VARIO30 LED clamp**  
docisk LED VARIO30

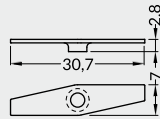

x 6 / 1 m

A9 C9 D9 E9

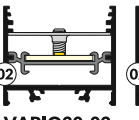

VARIO30-02

A9 C9 D9 E9

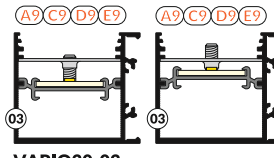

VARIO30-03

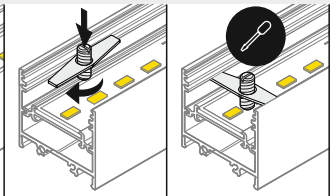
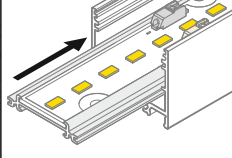
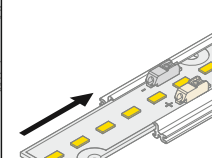
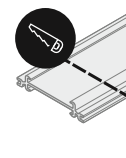

**VARIO30 LED mounting**  
mocowanie LED VARIO30

**VARIO30-02**  
**VARIO30-03**  
diffuser / klosz  
A9, C9, D9, E9

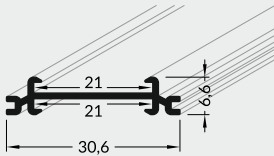

**VARIO30 LED 1 clamp**  
docisk LED VARIO30 1

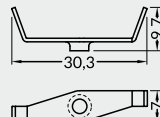

x 6 / 1 m

A9 C9 D9 E9

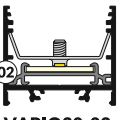

VARIO30-02

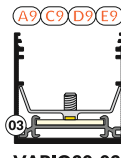

VARIO30-03

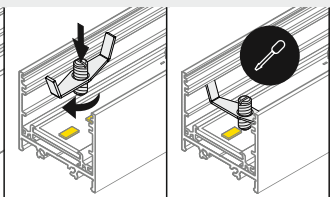
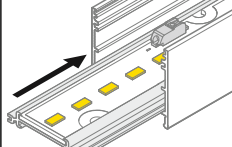
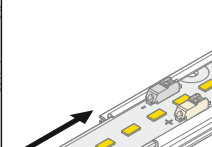
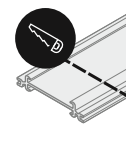

**VARIO30-02**  
**VARIO30-03**  
 diffuser / klosz  
**A9, C9, D9, E9**

**VARIO30 reflector**  
 odbłyśnik VARIO30

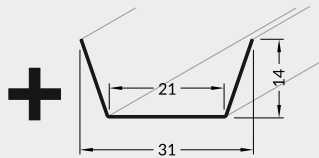

**VARIO30 LED 1 clamp**  
 docisk LED VARIO30 1

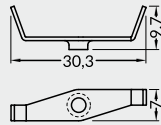

x 6 / 1 m

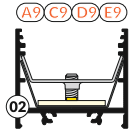

VARIO30-02

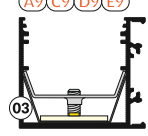

VARIO30-03

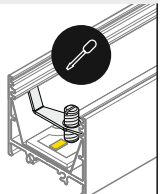
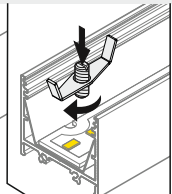
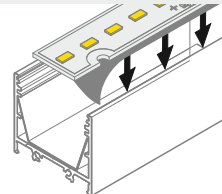
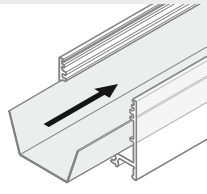
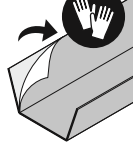
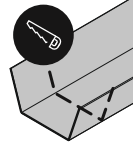

**double-sided adhesive thermally conductive tape 15 mm x 50 m**  
 taśma termoprzewodząca dwustronna 15 mm x 50 m

**V**

**VARIO30-01**  
**VARIO30-02**  
**VARIO30-03**  
 diffuser / klosz  
**A9, C9, D9, E9**

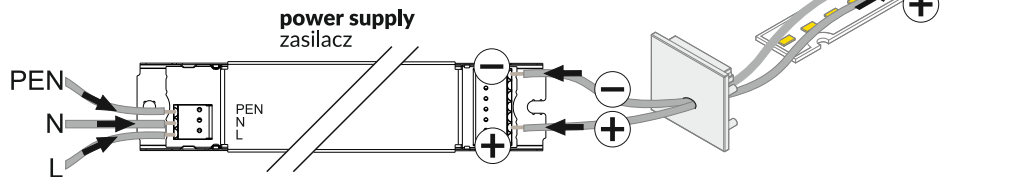

**Note!** Ending with marked space to bore the holes.  
**Possibility of buying dedicated screws.**  
**Uwaga!** Zaślepka z punktami do przewiercenia otworów. Istnieje możliwość zakupu dedykowanych wkrętów.

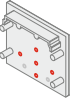

**VARIO30-01**  
**VARIO30-02**  
**VARIO30-03**  
 diffuser / klosz  
**A9**

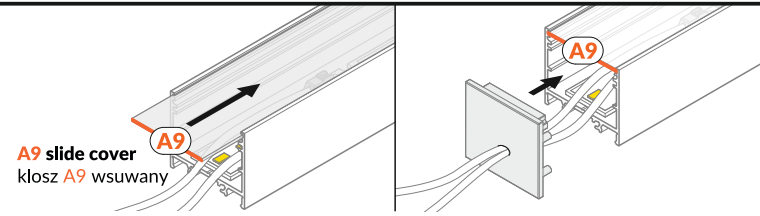

**A9 slide cover**  
 klosz A9 wsuwany

**VARIO30-01**  
**VARIO30-02**  
**VARIO30-03**  
 diffuser / klosz  
**C9**

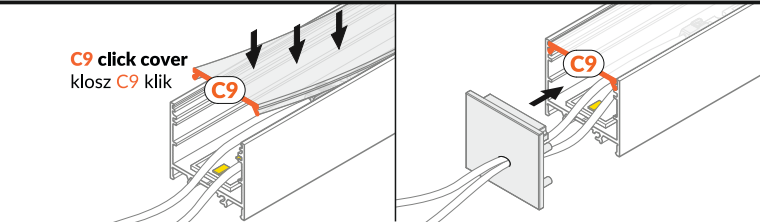

**C9 click cover**  
 klosz C9 klik

**VARIO30-01**  
**VARIO30-02**  
**VARIO30-03**  
 diffuser / klosz  
**E9**  
 ending / zaślepka  
**E9**

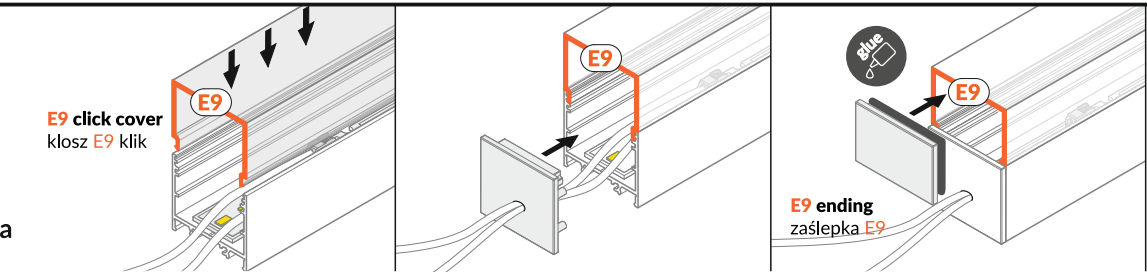

**E9 click cover**  
 klosz E9 klik

**E9 ending**  
 zaślepka E9

**VARIO30-01**  
**VARIO30-02**  
**VARIO30-03**  
 diffuser / klosz  
**D9**  
 ending / zaślepka  
**D9**

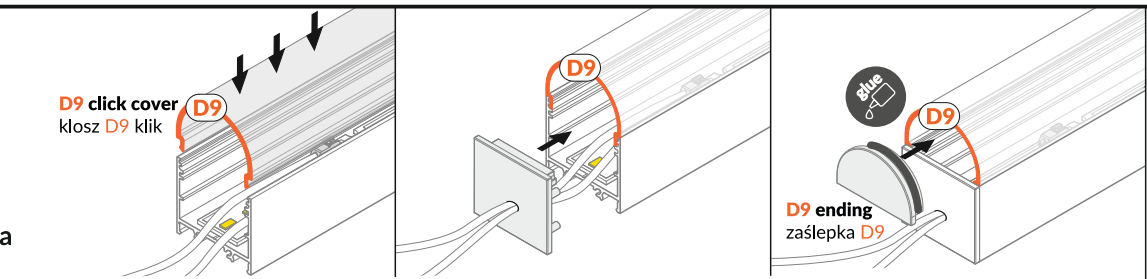

**D9 click cover**  
 klosz D9 klik

**D9 ending**  
 zaślepka D9

**VII**

**VARIO30-01**  
**VARIO30-02**  
**VARIO30-03**  
 diffuser / klosz  
**A9, C9, D9, E9**

**VARIO30-08**  
 power supply cover  
 osłona zasilacza

**VARIO30-01**  
**VARIO30-02**  
**VARIO30-03**

**VARIO30-08**

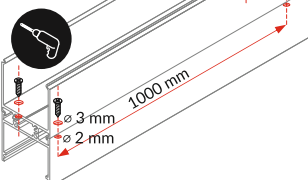
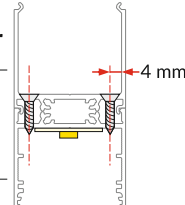

**wires cover Ø 5 mm**  
 osłona przewodów Ø 5 mm

**VARIO30-08**  
 power supply cover  
 osłona zasilacza

**VARIO30-01**  
**VARIO30-02**  
**VARIO30-03**

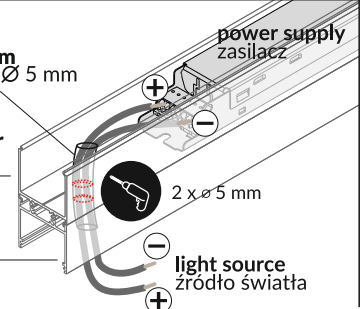

**light source**  
 źródło światła

**VIII METAL ENDINGS**  
ZAŚLEPKI METALOWE

**VARIANT 16-E9 / WARIANT 16-E9**

diffuser / klosz

E9

**VARIO30-16-E9 metal ending**  
zaślepka VARIO30-16-E9 metal

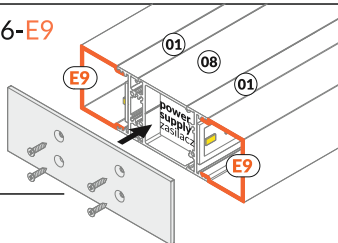

**VARIANT 19-E9 / WARIANT 19-E9**

diffuser / klosz

E9

**VARIO30-19-E9 metal ending**  
zaślepka VARIO30-19-E9 metal

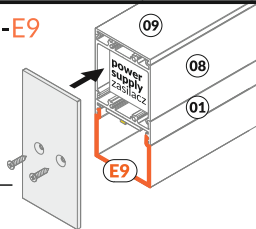

**VARIANT 27 / WARIANT 27**

diffuser / klosz

A9, C9, E9, D9

**VARIO30-27 metal ending**  
zaślepka VARIO30-27 metal

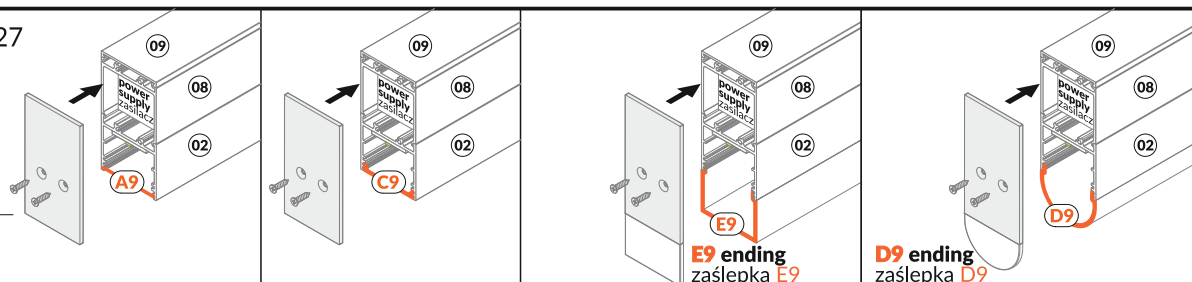

**VARIANT 32 / WARIANT 32**

diffuser / klosz

A9, C9, E9, D9

**VARIO30-32 metal ending**  
zaślepka VARIO30-32 metal

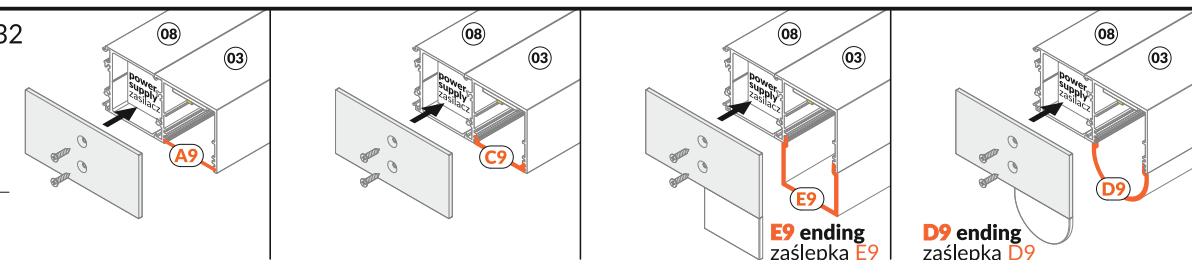

**VARIANT 34 / WARIANT 34**

diffuser / klosz

A9, C9, E9, D9

**VARIO30-34 metal ending**  
zaślepka VARIO30-34 metal

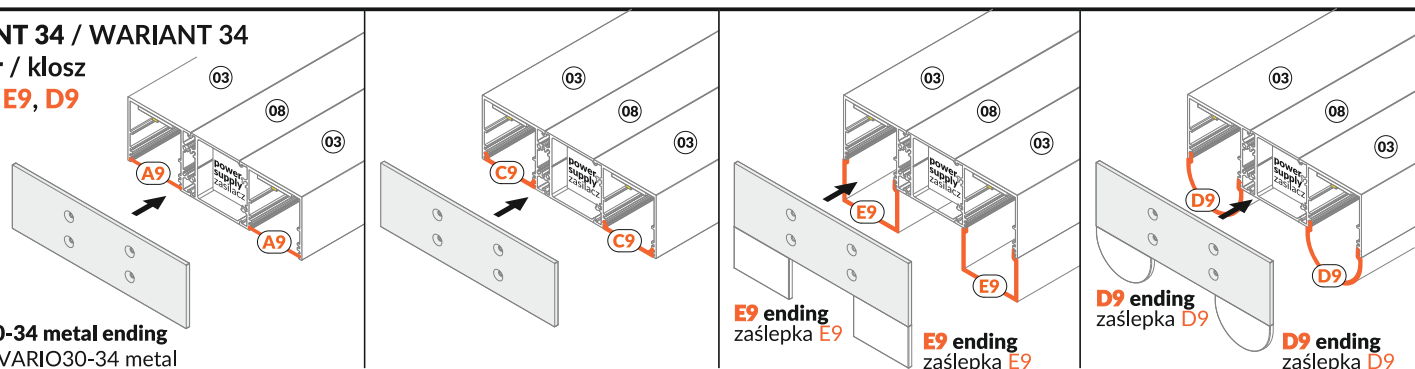

**IX MOUNTING / MONTAŻ**

**VARIO30-01**  
**VARIO30-02**  
**VARIO30-03**  
diffuser / klosz  
A9, C9, D9, E9

**Y flexible mounting plate**  
uchwyt Y sprężysty

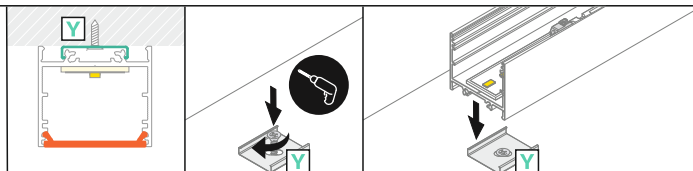

**cone Y flexible mounting plate**  
uchwyt Y sprężysty cone

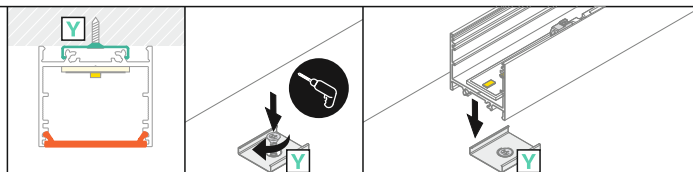

**T mounting plate**  
uchwyt T

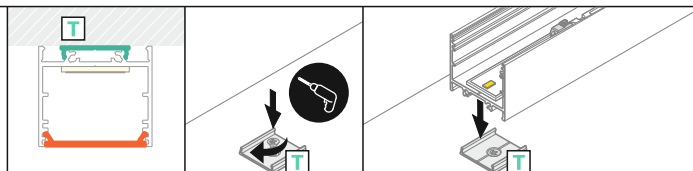



X

**VARIO30-01**  
**VARIO30-02**  
**VARIO30-03**  
**diffuser / klosz**  
**A9, C9, D9, E9**

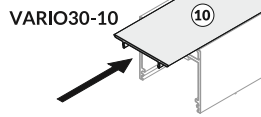

FIX16

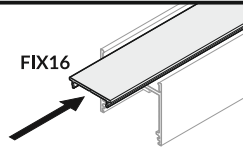

**VARIO30-08**

VARIO30-09

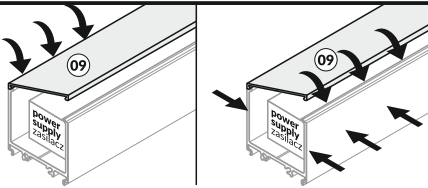

**XI CONNECTORS / ŁĄCZNIKI**

**VARIO30-02**  
**VARIO30-03**  
**diffuser / klosz**  
**A9, C9, D9, E9**

**Available angular connectors:**  
 Dostępne łączniki kątowe:

1. **VARIO30-02 connector 60 deg** / łącznik VARIO30-02 st
2. **VARIO30-02 connector 90 deg** / łącznik VARIO30-02 st
3. **VARIO30-02 connector 90 deg bent** / łącznik VARIO30-02 st gięty
4. **VARIO30-02 connector 135 deg** / łącznik VARIO30-02 st
5. **VARIO30-02 connector 180 deg** / łącznik VARIO30-02 st
6. **VARIO30-0203 connector 180 deg** / łącznik VARIO30-0203 st
7. **VARIO30-02 270 connector deg bent** / łącznik VARIO30-02 st gięty

**CONNECTION POSSIBILITIES**  
**MOŻLIWOŚCI ŁĄCZENIA**



**VARIO30-02**  
**VARIO30-03**  
**diffuser / klosz**  
**A9, C9, D9, E9**

**connector 180 deg**  
 łącznik 180 st

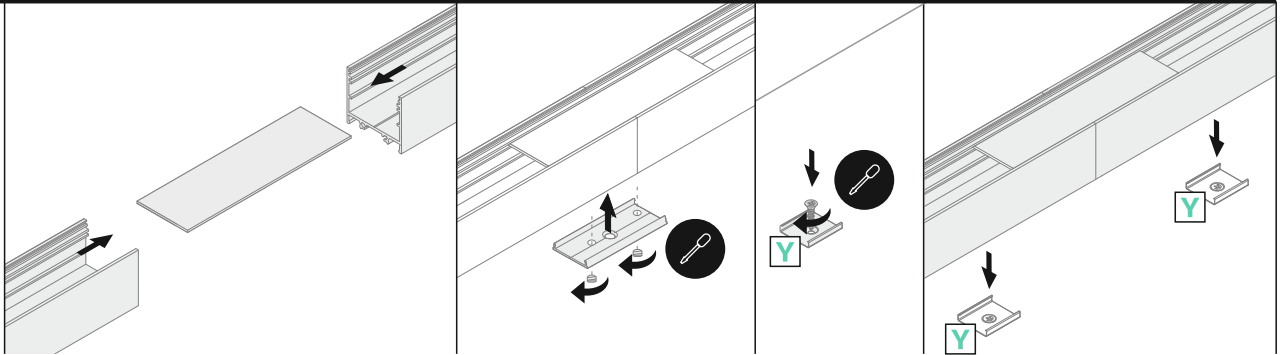

**VARIO30-02**  
**diffuser / klosz**  
**A9, C9, D9, E9**

**connector:**  
 60 deg, 90 deg,  
 90 deg bent, 135 deg,  
 270 deg bent  
 łącznik:  
 60 st, 90 st, 90 st gięty,  
 135 st, 270 st gięty

**VARIO30-02 connector 90 deg**  
 łącznik VARIO30-02 90 st

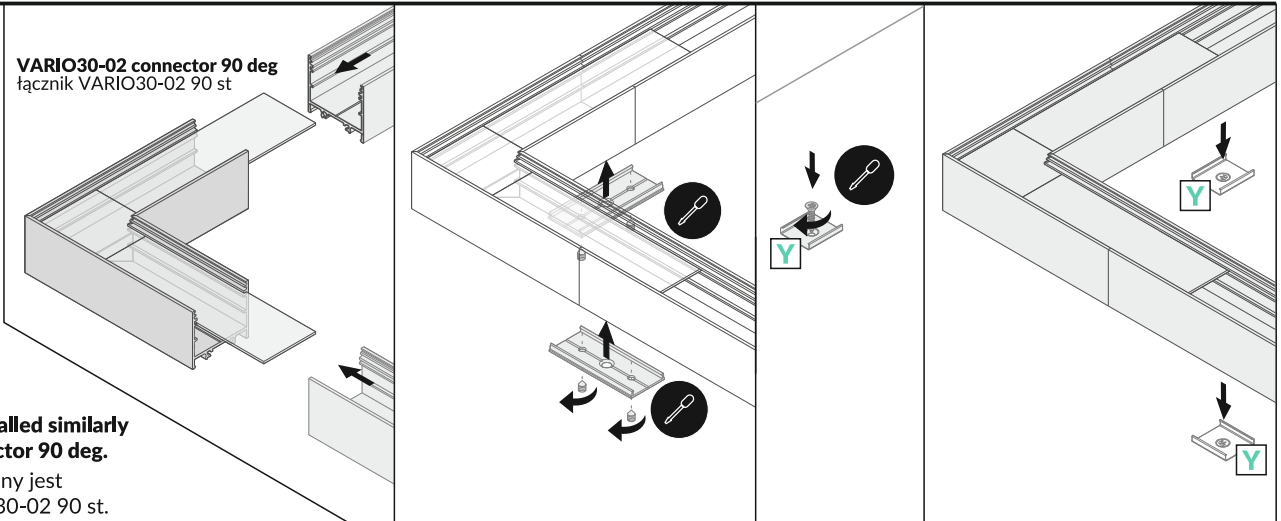

**Every connector is installed similarly to VARIO30-02 connector 90 deg.**  
 Każdy łącznik montowany jest analogicznie do VARIO30-02 90 st.

**XII POWER SUPPLY / ZASILANIE**

**VARIO30-01**  
**VARIO30-02**  
**VARIO30-03**  
**diffuser / klosz**  
**A9, C9, D9, E9**

**VARIO30-08**

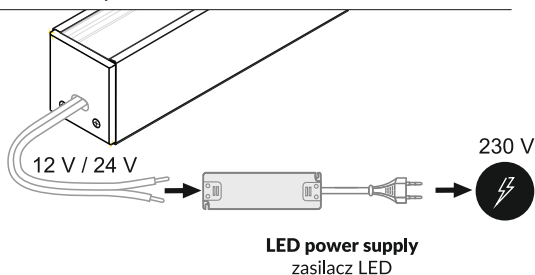

**LED power supply**  
 zasilacz LED

**ACCESSORIES / AKCESORIA**

**SELV sling - for more information check the SELV sling manual**  
 zawiesie SELV - więcej informacji w instrukcji lub [www.topmet.pl](http://www.topmet.pl)

**Check the rest - TOPMET catalogue on [www.topmet.pl/en](http://www.topmet.pl/en)**  
 Zobacz więcej - katalog TOPMET lub [www.topmet.pl](http://www.topmet.pl)

[www.topmet.pl](http://www.topmet.pl)

